

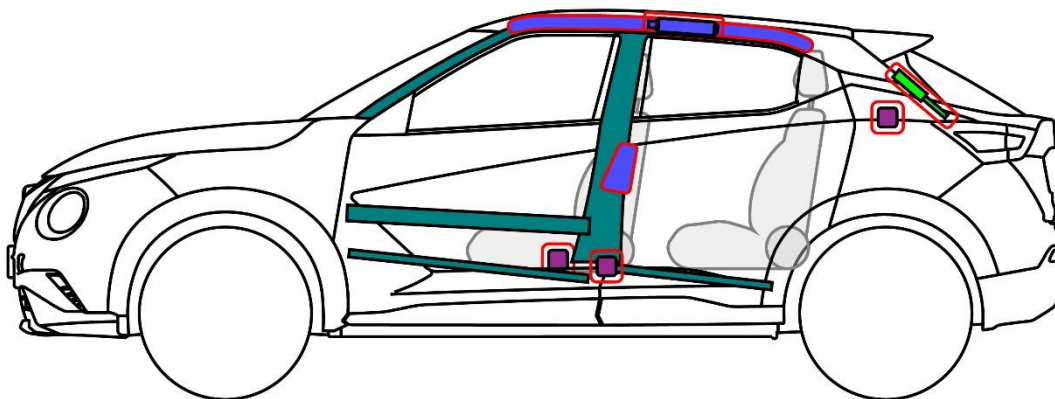

NISSAN

# Juke

TYPE: F16, 5-doors SUV  
(2019 - )

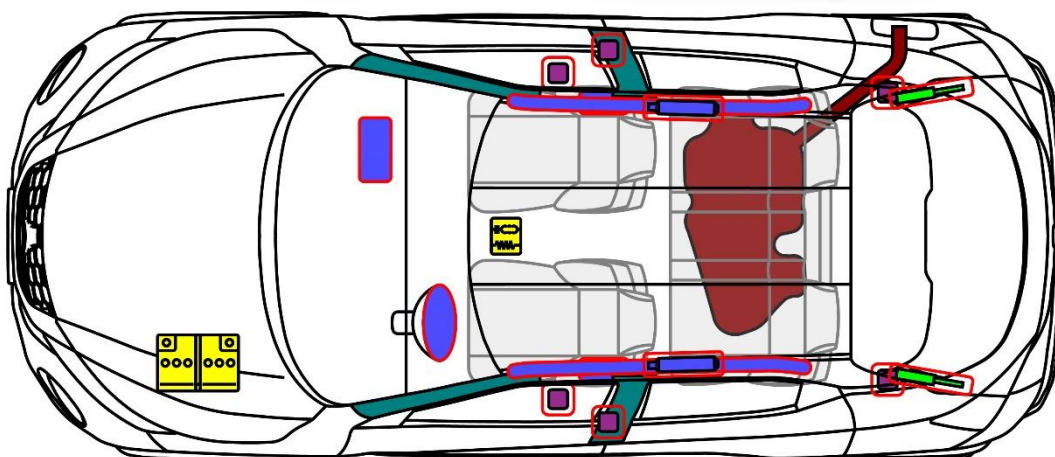

	Airbag		Stored gas inflator		Seat belt pretensioner		SRS control unit		Pedestrian protection active system
	Automatic rollover protection system		Gas strut / Preloaded spring		High strength zone		Zone requiring special attention		
	Battery low voltage		Ultra-capacitor, low voltage		Fuel tank		Gas tank		Safety valve
	Battery pack, high voltage		High voltage power cable / component		High voltage device that disconnects High voltage		Fuse box disabling high voltage		High voltage ultra-capacitor,
	Fuel tank content Gasoline / Ethanol								

1. Identification / recognition



2. Immobilization / stabilization / lifting

Immobilize vehicle:

1. Block wheels
2. For automatic transmission select the P (park) position
3. Set parking brake
4. Press start/stop button



Lifting points

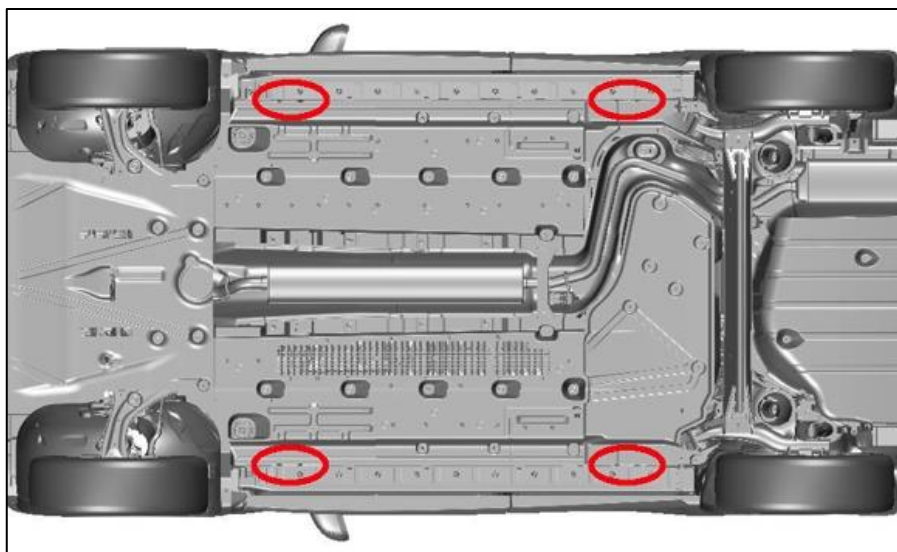

### 3. Disable direct hazards / safety regulations

Access to the engine compartment



Disconnect the 12 Volts battery

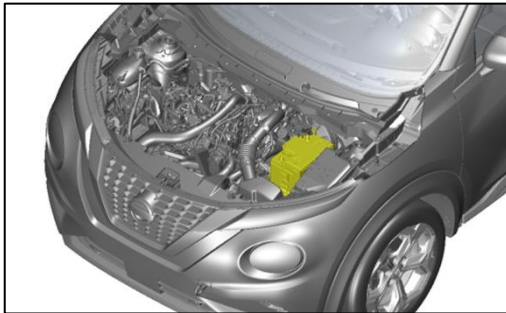
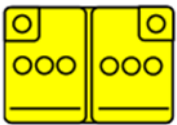

1. Switch off the ignition
2. Disconnect the negative terminal (-)
3. Disconnect the positive terminal (+)

### 4. Access to the occupants

High strength steel in body

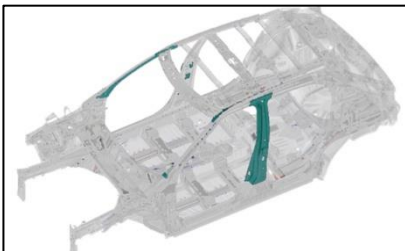

High strength steel in door

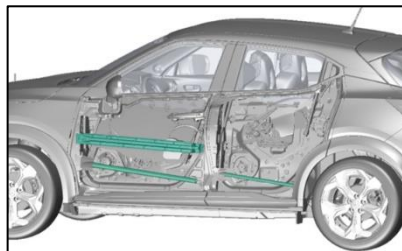

Steering column adjustment



Seat adjustment











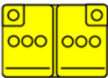

**Glass types:**

- A. Laminated glass.
- B. Tempered glass.





**5. Stored energy / liquids / gases / solids**

	12V	 
	R-1234yf 450 ±25 g	   
	46 L	 

**6. In case of fire**



**USE WATER**



**GAS STRUT, RISK OF MISSILE EFFECT**

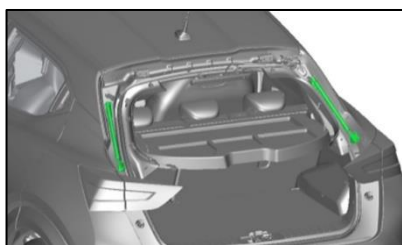

**8. Towing / transportation / storage**

Recovery hook storage



Location front hook













Location rear hook



Towing precautions



**10. Explanation of pictograms used**

	General warning sign		Flammable
	Warning; low temperature		Hazardous to the human health
	Air-conditioning component		Explosive
	Hybrid Electric Vehicle on fuel of liquid gr. 2		Corrosives
	Bonnet		Use water to extinguish the fire